

**SERIE 1300**



**SERIE 1300T**

 combina  
2/3 patas

Extractor mecánico 2/3 patas  
oscilantes  
3 jaws manual puller  
Extracteur à 3 griffes



**SERIE 1300AT**

Autocentrantes  
Self centering 2/3 jaws pullers  
Extracteur autocentrant 2/3 griffes



# SERIE 1300



Extractor mecánico 2 patas oscilantes, exterior  
 2 and 3 jaws puller  
 Extracteur à 2 et 3 griffes

Ref.	A	B	C	TON.	
1300	55	70	37	0,5	0,2
1301	85	100	70	1	0,4
1304	135	150	76	4	1,2
1307	180	200	113	7	2,3
1310	300	310	161	10	5,5
1317	365	425	280	17	11,5
1330	460	520	325	30	25,5
1350	750	850	402	50	49

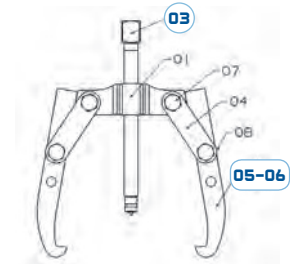

## SERIE 1300L

Ref.	A	B	C	TON.	
1300L	70	90	37	0,5	0,2
1301L	105	110	70	1	0,5
1304L	185	175	76	4	1,4
1307L	225	240	113,5	7	2,5
1310L	385	360	161	10	6
1317L	480	480	280	17	13
1330L	585	580	325	30	30

L: Pata larga · Long jaw · Griffes longue

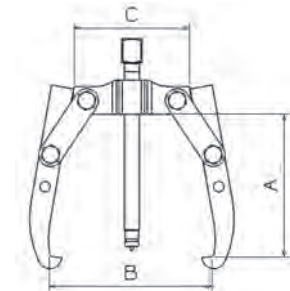

# SERIE 9300



Extractor mecánico 2 patas oscilantes  
 2 jaws puller  
 Extracteur à 2 griffes

Ref.	A	B	C	D	TON.	
9300	55	70	1,5	4,5	0,5	0,2
9301	85	100	2,5	6	1	0,5

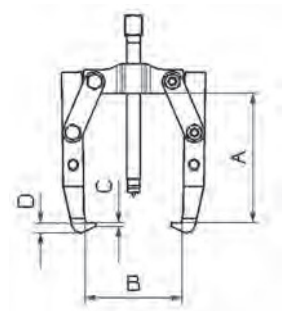

# SERIE 1300T

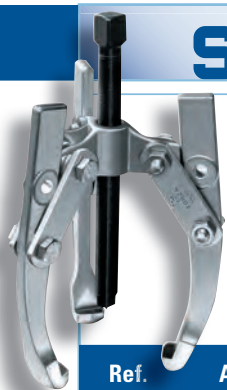

Extractor mecánico 2/3 patas oscilantes  
 2 and 3 jaws puller  
 Extracteur à 2 et 3 griffes

Ref.	A	B		C	TON.	
1300T	55	70	no	37	0,5	0,3
1301T	85	100	si	70	1	0,7
1304T	135	150	si	76	4	1,8
1307T	180	200	si	108	7	3,3
1310T	300	310	si	161	10	7,5
1317T	365	425	no	280	17	16,5
1330T	460	520	no	325	30	33,5
1350T	750	850	no	402	50	65

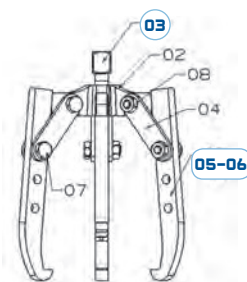

# SERIE 1300LT



  
 combina  
 2/3 patas

Ref.	A	B		C	TON.	
1300LT	70	90	no	47	0,5	0,3
1301LT	105	110	si	70	1	0,7
1304LT	185	175	si	76	4	2,1
1307LT	225	240	si	108	7	3,5
1310LT	385	360	si	161	10	8,5
1317LT	480	480	no	280	17	18,5
1330LT	585	580	no	325	30	39

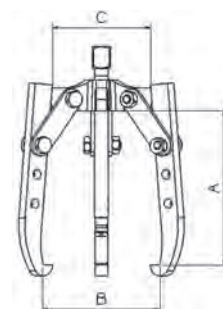



T: 3 patas · 3 jaws · 3 griffes  
 L: Pata larga · Long jaw · Griffes longue

# SERIE 9300T



Extractor mecánico 3 patas oscilantes  
 3 jaws puller  
 Extracteur à 3 griffes

Ref.	A	B		C	D	TON.	
9300T	55	70	no	1,5	4,5	0,5	0,3
9301T	85	100	si	2,5	6	1	0,7

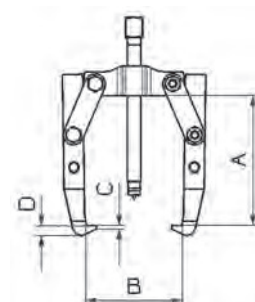

# CONJUNTOS / SET / JEUX

Estuche pequeños extractores

Small pullers set

Coffret petits extracteurs

## 1 TN

Ref.	se puede componer / can be composed / peut être composé	
9300K	9300 - 9300T - 9301 - 9301T	1,8



## 4 TN KIT COMBI

Ref.	se puede componer / can be composed / peut être composé	
9084	1002 - 1102 - 1202A - 5010 - 1304 - 1304T - 1404 - 1404T	6,5

## 7 TN KIT COMBI

Ref.	se puede componer / can be composed / peut être composé	
9087	1010 - 1110 - 1204B - 1307 - 1307L - 1307LT - 1407 - 1407T - 2301 - 2302	14,5









## SERIE 1300H

PH

### PARTE HIDRÁULICA · HYDRAULIC PART · PARTIE HYDRAULIQUE

Ref. PH	Tn		
00904	4	1307ALT	5,2
00910	10	1310TH-1310THA	11
00918	20	1318H-1318TH-1318THA	16
00930	30	1330H-1330TH-1330THA	19
00952	50	1352H-1352TH-1352THA	43



### CILINDRO · RAM · PISTON

Ref.	Ø A	C	H	Tm	Ref. HUSILLO	R	Ø P	r	
09041	38	76	178	4	-	-	25,4	-	1,5
09101	70	25	81	10	111083	3/4" UNF 16h	35,1	5/16" UNC 18h	2,5
09181	99	48	160	20	111883	1" UNC 8h	54,1	3/8" UNC 16h	7,5
09301	114	63	178	30	113083	1 1/4" UNC 7h	63,5	3/8" UNC 16h	10,5
09521	159	75	235	50	115283	1 5/8" UNS 5,5h	91,9	1/2" UNC 13 h	31

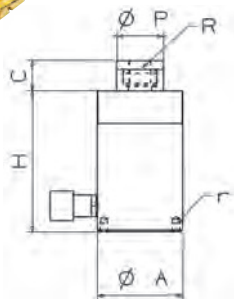

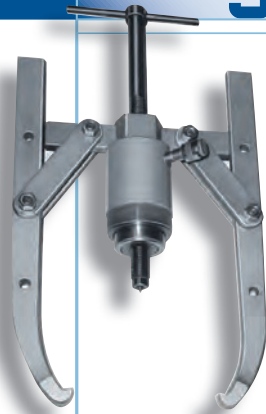

# SERIE 1300H

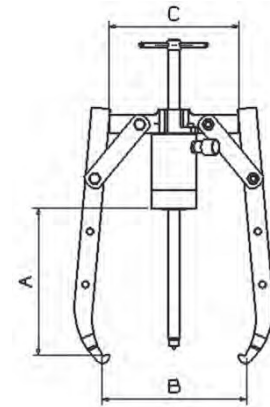
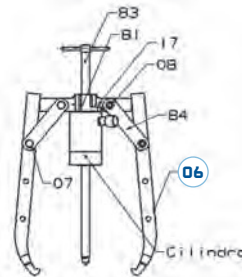

Extractor hidráulico 2 patas oscilantes, exterior  
 2 jaws hydraulic puller  
 Extracteur à 2 griffes hydraulique

PM: Parte mecánica  
 PH: Parte hidráulica



Ref. PM	A	B max	B min	C	Ref. PH	TON.	
<b>1318H</b>	320	480	70	280	<b>00918</b>	20	34
<b>1330H</b>	407	580	90	325	<b>00930</b>	30	49
<b>1352H</b>	727	920	120	414	<b>00952</b>	50	109

# SERIE 1300TH

Extractor hidráulico 3 patas oscilantes  
 3 jaws hydraulic puller  
 Extracteur à 3 griffes hydraulique

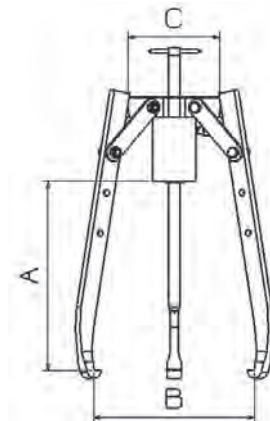
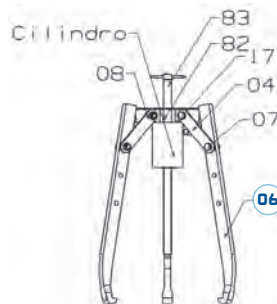

Ref. PM	A	B max	B min	C	Ref. PH	TON.	
<b>1310TH*</b>	296	350	50	176	<b>00910</b>	10	20
<b>1318TH</b>	320	480	70	277	<b>00918</b>	20	39
<b>1330TH</b>	407	580	90	322	<b>00930</b>	30	59
<b>1352TH</b>	750	1080	120	414	<b>00952</b>	50	130

(\*): 1310TH 2 y 3 patas · 1310TH 2 and 3 jaws · 1310TH 2 et 3 griffes

# SERIE 1300HC

Compactos  
Hydraulic 3 jaws pullers  
Extracteur hydraulique à 3 griffes

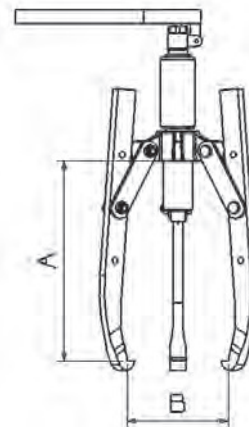
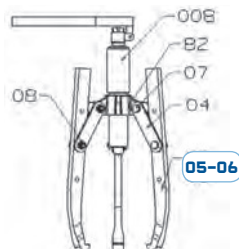

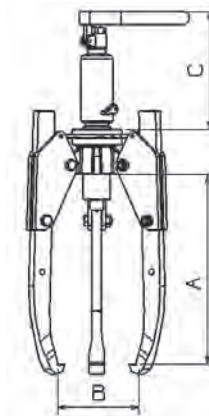
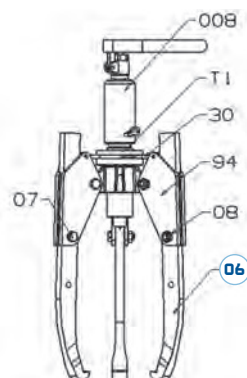

Ref.	A	B max	B min	TON.	
<b>1306CTH</b>	300	310	50	6	10,2
<b>1306CLTH</b>	385	360	50	6	11,2
<b>1308CTH</b>	365	425	70	8	19,5
<b>1308CLTH</b>	480	480	70	8	21,5



Ref.	A	B max	B min	C	TON.	
<b>1306CTA</b>	300	310	50	220	6	10,2
<b>1306CLTA</b>	385	360	50	220	6	11,2
<b>1308CTA</b>	365	425	70	205	8	19,5
<b>1308CLTA</b>	480	480	70	205	8	21,5

## COMPACTOS BOMBA Y CILINDRO INTEGRADOS

Ref.	CARRERA stroke		CILINDRO ram/piston	TON	
<b>00806</b>	62	1306CTH-1306CLTH-1306CTA-1306CLTA	integrado	6	3,1
<b>00808</b>	82	1308CTH-1308CLTH-1308CTA-1308CLTA	integrado	8	3,8

Ref.	TON	A	B	ØC	D	E	ØF	ØG	ØH
<b>00806</b>	6	340	310	23	120	115	22	45	54
<b>00808</b>	8	360	310	23	155	115	22	50	60

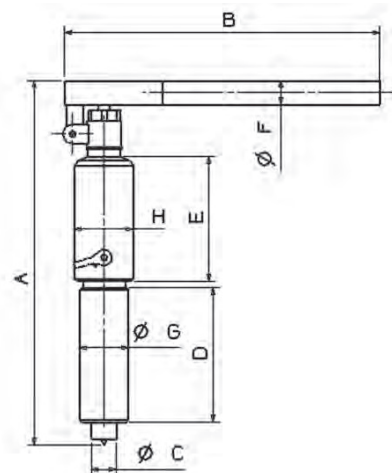

# CONJUNTOS

Conjuntos hidráulicos

Hydraulic pullers set

Jeux d'extracteur hydraulique

PM: Parte mecánica

PH: Parte hidráulica

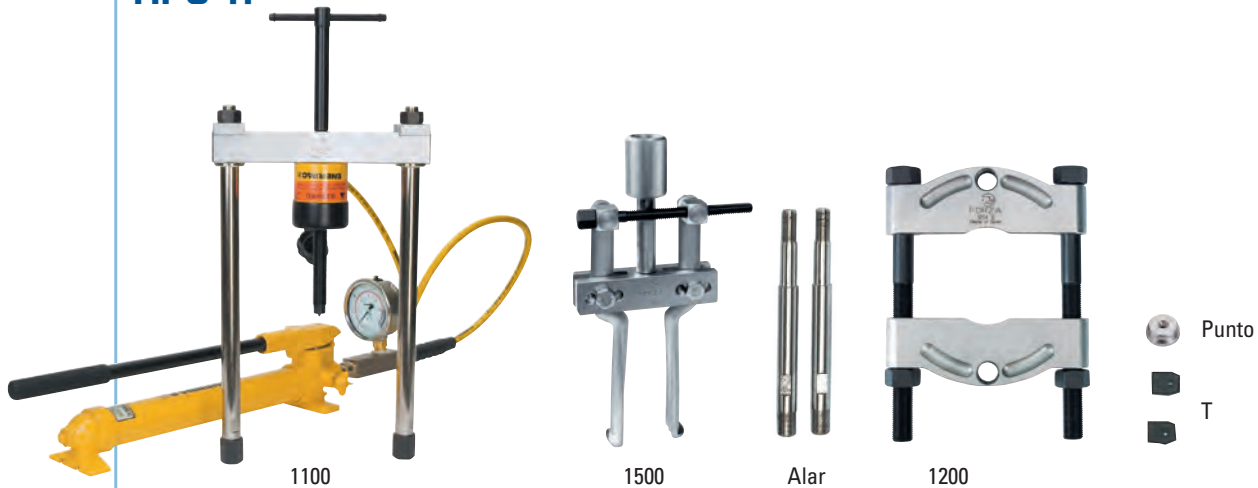

## TIPO K

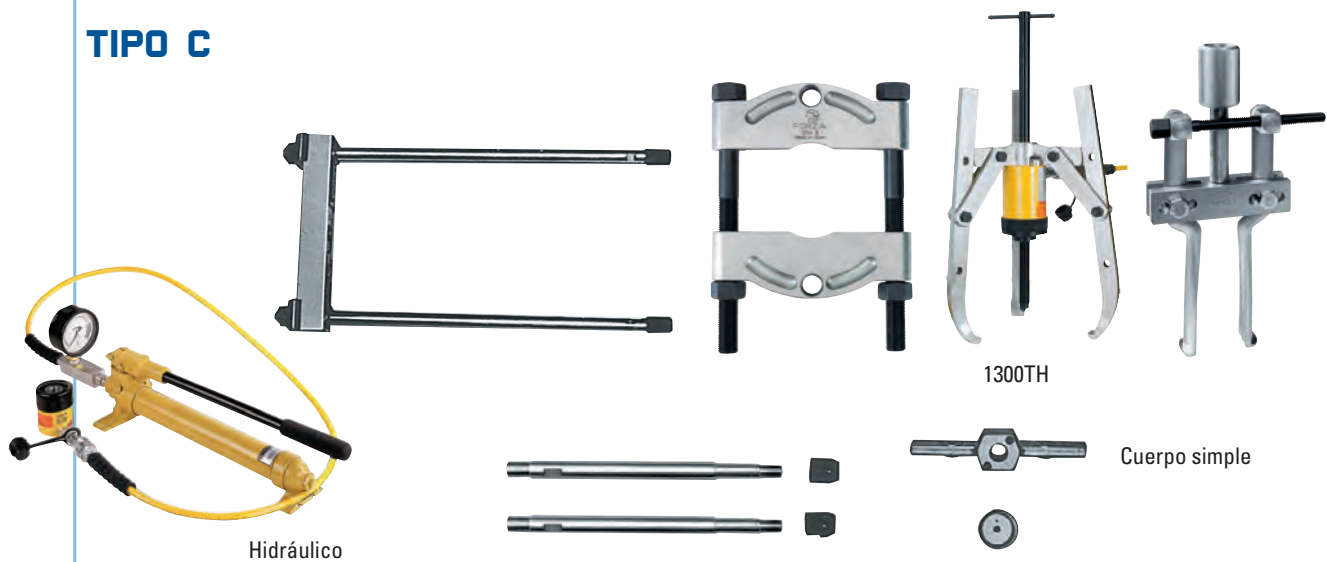

Ref. PM	Ref. PH	Ton	1100 1x	1200 1x	1500H 1x	Punto 1x	T 2x	Alarg. Standard	Alarg. Extra	
<b>K0-10</b>	<b>00910</b>	10	1110H	1204B	1506H10	111037	111017	1110-460H	1110-209H	27
<b>K1-18</b>	<b>00918</b>	20	1118H	1206B	1506H20	111837	112017	1120-515	1120-209	38
<b>K2-30</b>	<b>00930</b>	30	1130H	1210C	1509H30	113037	113517	1130-582	1130-328	80
<b>K3-45</b>	<b>00952</b>	50	1152H	1210D	1509H50	113037	115017	1152-820	1152-504	128
<b>K3-50</b>	<b>00952</b>	50	1152H	1212D	1509H50	113037	115017	1152-820	1152-504	143

## TIPO C



Ref. PM	Ref. PH	Ton	1100 1x	1200 1x	1500H 1x	Punto 1x	T 2x	Alarg. Standard	Alarg. Extra	1300TH 1x	Cuerpo 1x	
<b>C0-10</b>	<b>00910</b>	10	1110H	1204B	1506H10	111037	111017	1110-460H	1110-209H	1310TH		35
<b>C1-18</b>	<b>00918</b>	20	1118H	1206B	1506H20	111837	112017	1120-515	1120-209	1318TH	131881	60
<b>C2-30</b>	<b>00930</b>	30	1130H	1210C	1509H30	113037	113517	1130-582	1130-328	1330TH	133081	120
<b>C3-45</b>	<b>00952</b>	50	1152H	1210D	1509H50	113037	115017	1152-820	1152-504	1352TH	135281	215
<b>C3-50</b>	<b>00952</b>	50	1152H	1212D	1509H50	113037	115017	1152-820	1152-504	1352TH	135281	230
<b>C3-52</b>	<b>00952</b>	50	1152H	1213D	1509H50	113037	115017	1152-820	1152-504	1352TH	135281	270



## 8 TON



Extractor hidráulico 8 TON

Hydraulic puller 8 TON

Extracteur hydraulique de 8 Tonnes

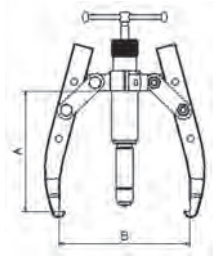
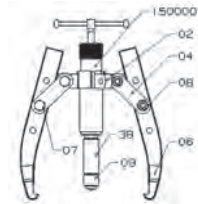

Ref.	A	B	
1308TH	225	240	4

### CONJUNTOS • SETS • JEUX

Ref.	se puede componer / can be composed / peut être composé	
C1004	1010H / 1108H / 1204B / 1010LH alargaderas	11,3
C1005	1010H / 1108H / 1204B / 1010LH alargaderas / 1308TH	14,5
C1006	1010 AH / 1010 LAH / 1206 B / 1108 AH alargaderas	15

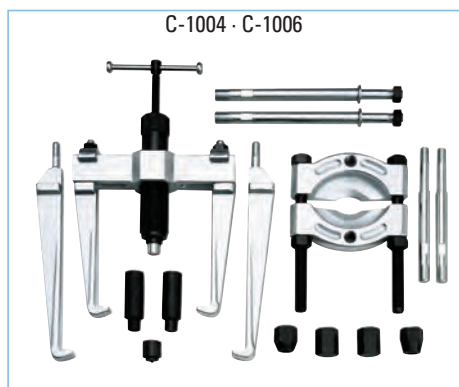

### SE PUEDEN COMPONER



# 4 TON

Extractor hidráulico 4 TON  
 Hydraulic puller 4 TON  
 Extracteur hydraulique de 4 Tonnes

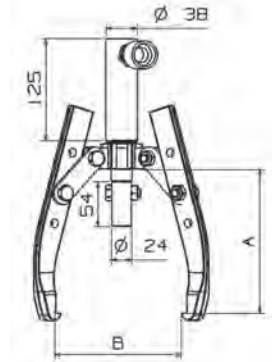

Ref. PM	Ref. PH	A	B	
1307LTH	00904	225	240	4

## C1008

Conjunto hidráulico 8 TON  
 8 TON hydraulic puller set  
 Jeux d'extracteur hydraulique 8 Tonnes



00904

### CONJUNTOS · SETS · JEUX

Ref. PM	Ref. PH	contenido / content / conten
C1008	00904	1-00904 1-1110HF 1-1307HPM 1-1204B 2-101060 2-1110-180



1204B



1307HPM



101060





1110-180

## SERIE 1300AT

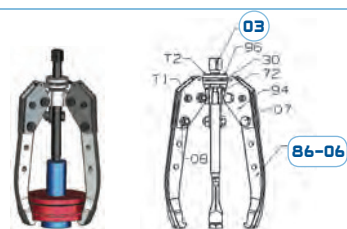

Autocentrantes  
Self centering 2/3 jaws pullers  
Extracteur autocentrant 2/3 griffes



Ref.	A	B	B min		C	TON.	
1301ALT	105	110	15	si	79,5	1	1
1304ALT	185	175	25	si	104	4	2,5
1307ALT	225	240	40	si	108	7	6,5
1310ALT	385	360	50	si	176	10	14,5
1317ALT	480	480	70	no	276	17	31,5
1330ALT	585	580	90	no	322	30	55,5

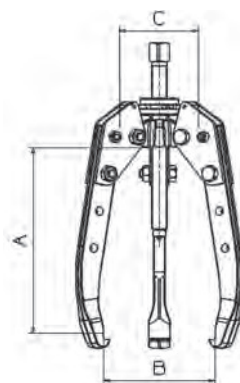

A: Autocentrante  
L: Pata larga · Long jaw · Griffes longue  
T: 3 patas · 3 jaws · 3 griffes

### EXPOSITOR · MERCHANDISER · PRÉSENTOIR



Ref.	composición	
1300A	1301 ALT-1304ALT-1307ALT	13

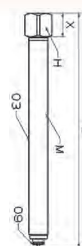

03  
31

### HUSILLO · SPINDLE · VIS MECÁNICO





Ref.	M	L	X	H		
130003	8 x 1	90	12	9	fijo	1300 / 1300T
130103	10 x 1	124	14	12	fijo	1301 / 1301T / 1301L / 1301LT / 1301ALT
130403	14 x 1,50	177	20	16	fijo	1304 / 1304T / 1304L / 1304LT / 1304ALT
130703	18 x 1,50	235	24	19	fijo	1307 / 1307T / 1307L / 1307LT / 1307ALT
131032	20 x 1,50	321	25	22	www	1310 / 1310T / 1310L / 1310LT / 1310ALT
131731	27 x 2	377	30	27	www	1317 / 1317T / 1317L / 1317LT / 1317ALT
133031	1 3/8" 12h.	510	38	35	www	1330 / 1330T / 1330L / 1330LT / 1330ALT
135231	1 3/8" 12h.	535	38	35	www	1352 / 1352T

Husillo 31 = Husillo (03) + Punto (09)

83

### HUSILLO · SPINDLE · VIS HIDRÁULICO



Ref.	M	L	Cabeza			R
111083	3/4" UNF 16h	400	manilla	fijo	1310H-1310TH-1310THA	222
111883	1" UNC 8h	670	manilla	fijo	1318H-1318TH-1318THA	348
113083	1 1/4" UNC 7h	790	manilla	fijo	1330H-1330TH-1330THA	427
115283	1 5/8" UNS 5,5h	975	manilla	fijo	1352H-1352TH-1352THA	530

# SERIE 1300THA

Extractor hidráulico 3 patas autocentrante  
 Self centering 3 jaws hydraulic puller  
 Extracteur hydraulique autocentrant 3 griffes

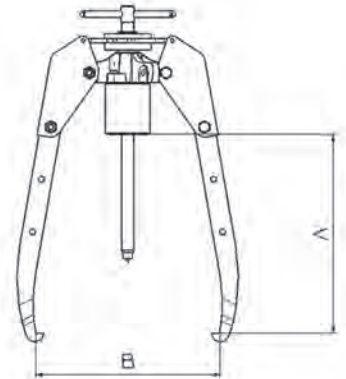
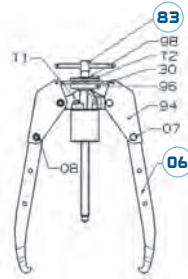

Ref.	A	B max	B min	TON.	
<b>1310THA*</b>	296	350	50	10	25,5
<b>1318THA</b>	320	480	70	20	49
<b>1330THA</b>	407	580	90	30	75,5
<b>1352THA</b>	750	1080	120	50	177

(\*): 1310TH 2 y 3 patas · 1310TH 2 and 3 jaws · 1310TH 2 et 3 griffes

A: Autocentrante  
 H: Hidráulico  
 T: 3 patas · 3 jaws · 3 griffes

**05-06**  
-86



**PATA · JAW · GRIFFE**

05: Corta · Short · Courte  
 06: Larga · Long · Longue

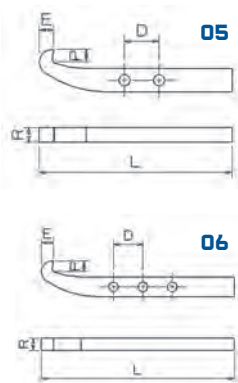

Ref.	P	R	E	L	D	
<b>130005</b>	4,5	6,5	5	70	13	1300 / 1300T
<b>130006</b>	4,5	6,5	5	85	13	1300L / 1300LT
<b>130105</b>	6,5	8	7	106	19	1301 / 1301T
<b>130106</b>	7	7,5	8	127	19	1301L / 1301LT
<b>130186</b>	7	7,5	8	127	19	1301ALT
<b>130405</b>	7	21	7	166	51	1304 / 1304T
<b>130406</b>	8	21	7,5	219	51	1304L / 1304LT
<b>130486</b>	8	21	7,5	219	51	1304ALT
<b>130705</b>	8,5	25	9	217	44,5	1307 / 1307T
<b>130706</b>	8	25	10	264	44,5	1307L / 1307LT
<b>130786</b>	8	25	10	264	44,5	1307ALT
<b>131005</b>	15	25	12,5	355	83	1310 / 1310T
<b>131006</b>	15	25	12,5	436	83	1310L / 1310LT / 1310ALT
<b>131705</b>	15,5	32	16	435	115	1317 / 1317T
<b>131706</b>	17,5	31	15,5	550	115	1317L / 1317LT / 1317ALT
<b>133005</b>	23	42	22	557	125	1330 / 1330T
<b>133006</b>	24	41	22	698	125	1330L / 1330LT
<b>135205</b>	31	50	30	1065	150	1350 / 1350T





**SERIE 1400LT**

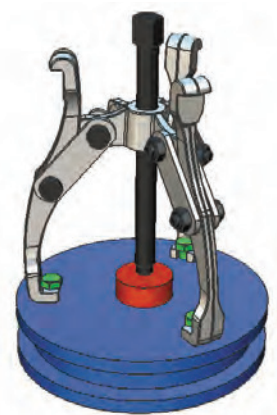



# SERIE 1400

Extractor mecánico 2 patas reversibles  
 2 jaws reversible puller  
 Extracteur 2 griffes reversibles

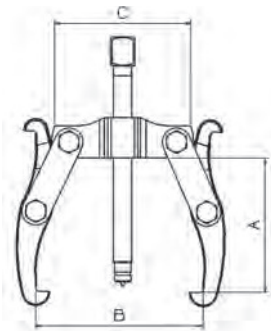
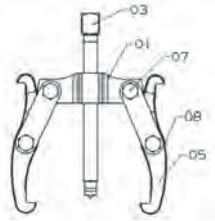

Ref.	A	B	C	TON.	
1401	65	100	70	1	0,3
1404	85	135	76	4	1
1407	125	200	113	7	2,1
1410	260	320	161	10	4,5

# SERIE 1400L



Ref.	A	B	C	TON.	
1401L	85	120	70	1	0,5
1404L	135	160	76	4	1,2
1407L	180	225	113	7	2,7

L: Pata larga · Long jaw · Griffes longue

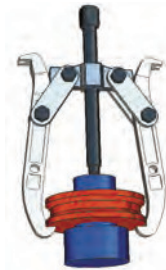
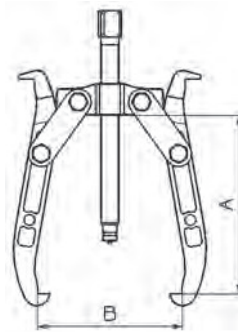

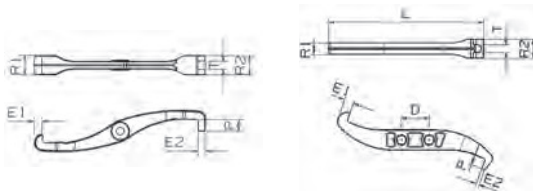

**05-06**  **PATA · JAW · GRIFFE**  
 05: Corta · Short · Courte  
 06: Larga · Long · Longue

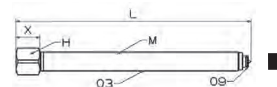

**03**  **HUSILLO · SPINDLE · VIS**  
**31** 09: Punto · Point · Point 



Ref.	P	P	R1	R2	E1	E2	L	D	T	
140105	6	5	6,7	14	7	6	93	no	no	1401 / 1401T
140405	9	6,5	8	18	10	8	126	no	no	1404 / 1404T
140705	11	9,5	25	25	11	9,5	211	no	10,5	1407 / 1407T
141005	15,5	20	25,8	27	12,5	14,2	300	50	12	1410 / 1410T
140106	6	7	8	13	7	3	110	19	5	1401L / 1401LT
140406	9,5	11,5	10	17	10	6	178	51	6	1404L / 1404LT
140706	11	15	13	25	11	4	260	44,5	8	1407L / 1407LT

Ref.	M	L	X	H		
130103	10 x 1	124	14,5	12	■	fijo 1401 / 1401T / 1401L / 1401LT
130403	14 x 1,50	180	20,5	16	■	fijo 1404 / 1404T / 1404L / 1404LT
130703	18 x 1,50	250	24	19	■	fijo 1407 / 1407T / 1407L / 1407LT
131031	20 x 1,50	330	25	22	■	www 1410 / 1410T / 1410L / 1410LT

Husillo 31 = Husillo (03) + Punto (09)

# SERIE 1400T



Extractor mecánico 2 y 3 patas reversibles  
 2 and 3 jaws reversible puller  
 Extracteur 2 et 3 griffes reversibles

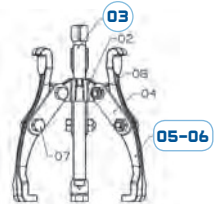

  
 combina  
 2/3 patas

Ref.	A	B		C	TON.	
1401T	65	80	si	80	1	0,3
1404T	85	150	si	106	4	1
1407T	125	200	si	109	7	2,1
1410T	260	320	si	176	10	4,5

T: 3 patas - 3 jaws - 3 griffes

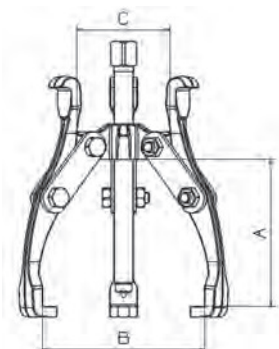

# SERIE 1400LT



Extractor mecánico 2 y 3 patas reversibles  
 2 and 3 jaws reversible puller  
 Extracteur 2 et 3 griffes reversibles

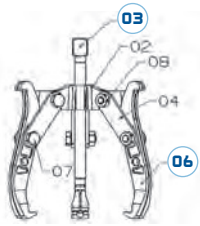

  
 combina  
 2/3 patas

Ref.	A	B		C	TON.	
1401LT	85	130	si	80	1	0,6
1404LT	135	180	si	106	4	1,2
1407LT	180	235	si	109	7	3,8

L: Pata larga · long jaw · griffe longue  
 T: 3 patas - 3 jaws - 3 griffes

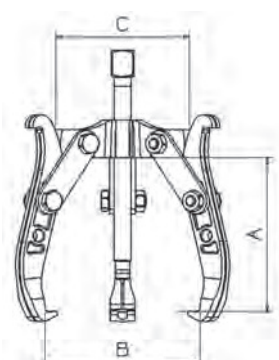

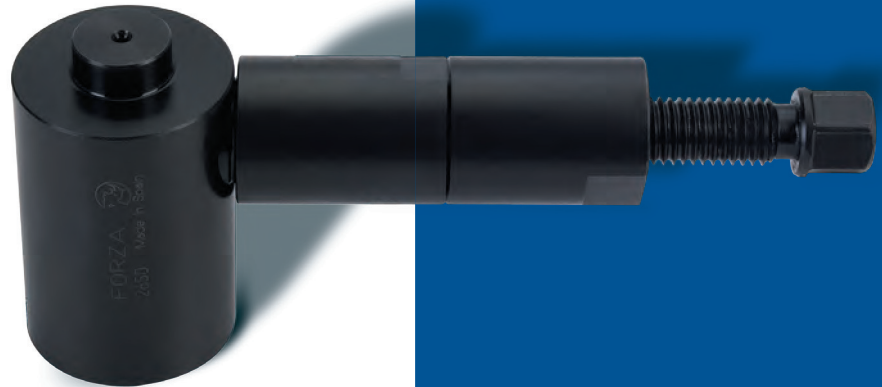

Ref.	ØA	ØB	ØC	D	E	F	G	Carrera	TON.	⚖
2650	45	25	20	73	8	170	103	5	5	1,3
2655	70	25	28	82	12	170	103	5	11	2,4

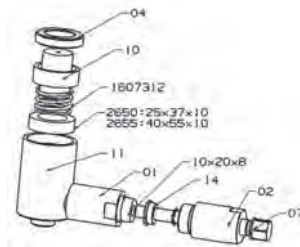
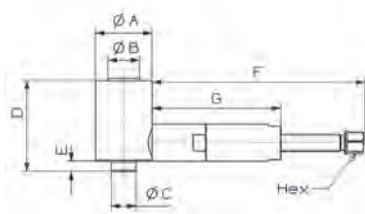

EXTRACTOR DE PASADORES ROSCADOS · **THREADED PIN EXTRACTOR** ·  
EXTRACTEUR DE BROCHES FILETÉES



CONJUNTO · **SET** · **JEU**

Ref.	⚖
1950	Completo / Full set / Jeu complet 1,5

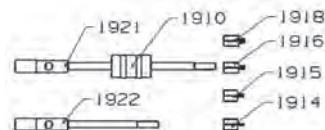
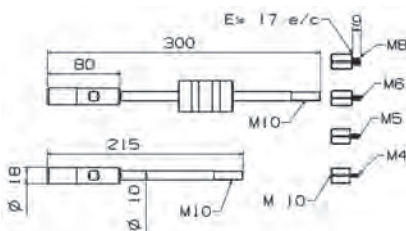



**SERIE 7300**

**7301LT**



**7301ALT**

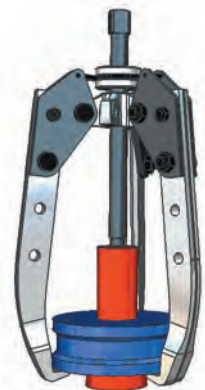

# SERIE 7300

Extractor mecánico 2 patas oscilantes, exterior  
 2 jaws puller  
 Extracteur à 2 griffes

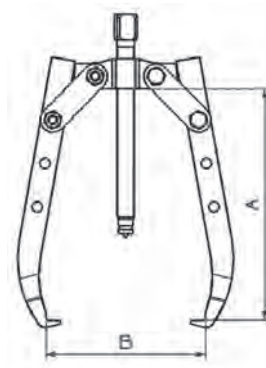
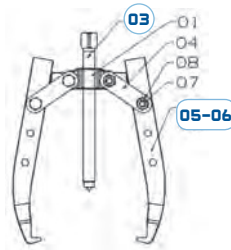

Ref.	A	B	Ref. pata	
<b>7301</b>	105	110	730105	0,4
<b>7304</b>	185	175	730405	1,3
<b>7307</b>	225	240	730705	2,8

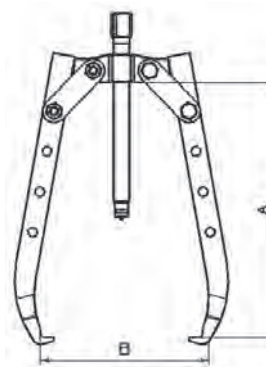
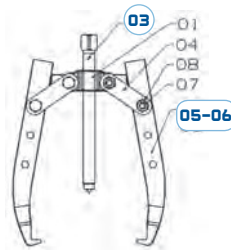
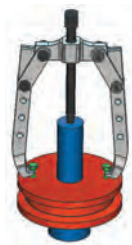
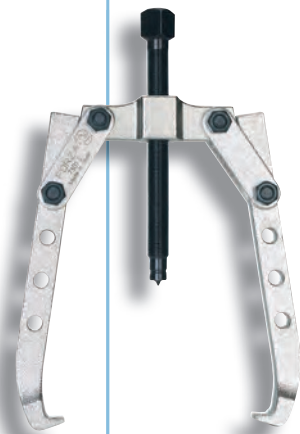

Ref.	A	B	Ref. pata	
<b>7301L</b>	120	125	730106	0,5
<b>7304L</b>	210	220	730406	1,4
<b>7307L</b>	270	280	730706	3,0



L: Pata larga · long jaw · griffe longue



# SERIE 7300T





Extractor mecánico 2 y 3 patas oscilantes, exterior  
 2 and 3 jaws puller  
 Extracteur à 2 et 3 griffes

Ref.	A	B	Ref. pata	 combina 2/3 patas	
7301T	105	110	730105	si	0,7
7304T	185	175	730405	si	1,9
7307T	225	240	730705	si	3,5

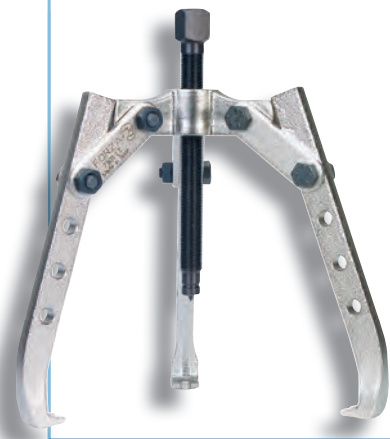
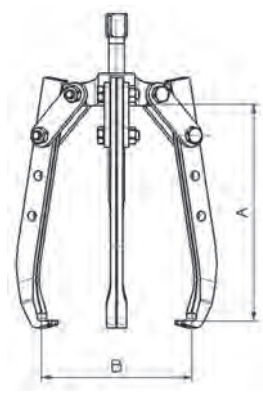
T: 3 patas · 3 jaws · 3 griffes



# SERIE 7300LT

Ref.	A	B	Ref. pata	 combina 2/3 patas	
7301LT	120	125	730106	si	0,7
7304LT	210	220	730406	si	2,1
7307LT	270	280	730706	si	3,7

L: Pata larga · long jaw · griffe longue

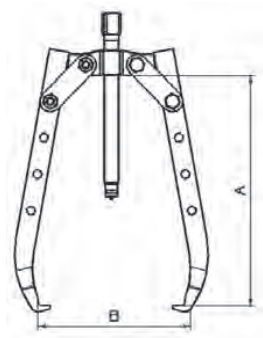
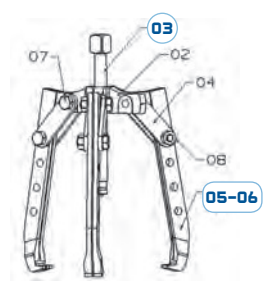



**03**

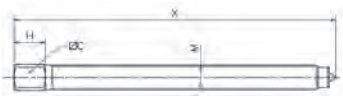

**HUSILLO · SPINDLE · VIS**



Ref.	M	L	X	H		
130103	10 x 1	124	14	12	fijo	7301-7301L-7301LT-7301AT-7301ALT
130403	14 x 1,50	177	20	16	fijo	7304-7304L-7304LT-7304AT-7304ALT
130703	18 x 1,50	235	24	19	fijo	7307-7307L-7307LT-7307AT-7307ALT